

ONLY THE BEST GET
BRANDED
BRANDEDMFG.COM

805 INDUSTRIAL PARK DR. TRENTON, TN 38382

PH: 731-345-4500

WWW.BRANDEDMFG.COM

True-L Grecian Right Order Form

Date: _____ Due: _____

DEALER

Company: _____
Address: _____
CITY _____ STATE _____ ZIP _____
Contact: _____ Phone: _____
E-Mail: _____

DISTRIBUTOR

Company: _____
Address: _____
CITY _____ STATE _____ ZIP _____
Contact: _____ Phone: _____
E-Mail: _____

SHIPPING INSTRUCTIONS

Branch: Dealer: Pick Up:

Ship Via: _____

Other: _____

ORDER INFORMATION

PO #: _____
Job Name: _____
Price: _____
Barcode: _____

Wall Pattern: _____

Floor Pattern: _____

MOUNTING

Beaded: Overlap: Overlap Size: _____ INCHES

COMMENTS

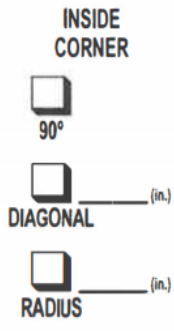
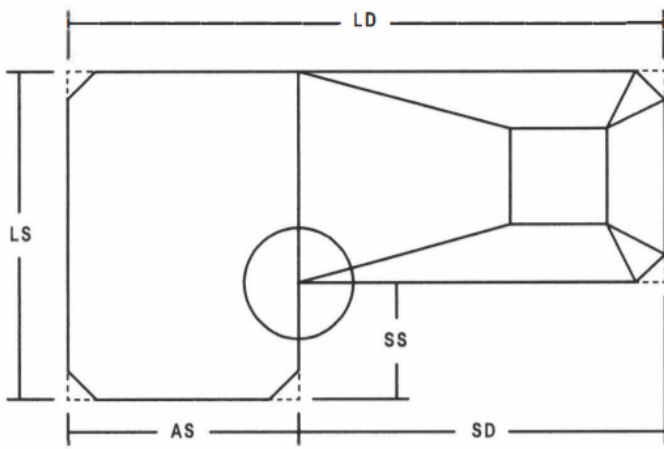

GRECIAN CORNERS

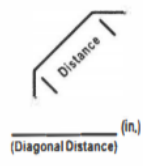

!! NOTE !!
MEASURE TO SQUARED CORNERS

HOPPER

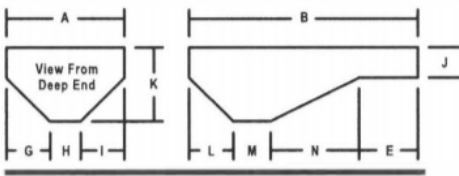
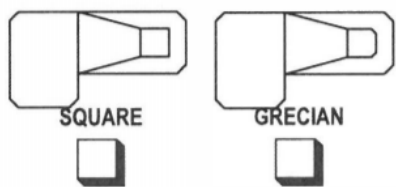

SAFETY LEDGE



COVE

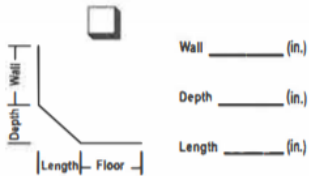

MEASUREMENTS

- (A): _____ (ft.) _____ (in.) (L): _____ (ft.) _____ (in.)
- (B): _____ (ft.) _____ (in.) (M): _____ (ft.) _____ (in.)
- (E): _____ (ft.) _____ (in.) (N): _____ (ft.) _____ (in.)
- (G): _____ (ft.) _____ (in.) (AS): _____ (ft.) _____ (in.)
- (H): _____ (ft.) _____ (in.) (LD): _____ (ft.) _____ (in.)
- (I): _____ (ft.) _____ (in.) (LS): _____ (ft.) _____ (in.)
- (J): _____ (ft.) _____ (in.) (SD): _____ (ft.) _____ (in.)
- (K): _____ (ft.) _____ (in.) (SS): _____ (ft.) _____ (in.)

POOL MANUFACTURER, IF KNOWN:

DO NOT INCLUDE STEPS ACROSS THE WIDTH OF THE POOL IN THE OVERALL LENGTH 'B' MEASUREMENT

STEP DETAILS

INDICATE POSITION OF VINYL STEP IF APPLICABLE

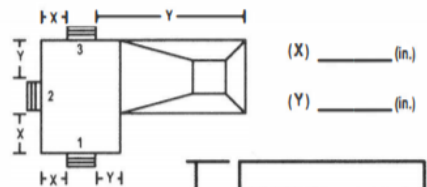

IS STEP INSIDE POOL PERIMETER?
YES NO

VINYL STEP

ROD POCKETS YES NO

BEADED STEP YES NO

FOAM

YES NO

Set Back

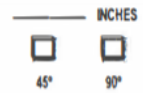

Step Corners



Self Check
G+H+I=A?
E+L+M+N=B?
STEP RISERS=J?